



System Saver

Hydraulic Vane Pump & Valve Assemblies

Reduce Installation Costs with VELJAN Compact, Low Noise, No Leak, Pre Assembled Sub-Systems

Easy to Specify

Easy to Order

Completely Assembled

Ready to Install

Made from Standard Components

Hydraulic Vane Pump & Valve Assemblies



Ready to Install

Standard components in any package are pre-tested to their full performance specifications.

Reduced Overall Installation Costs

Easy specification of required sub-system along with quick assembly and no charge for mounting hardware, combine to make the "System Saver" very cost-effective. SAE flange and hose connections are sized to the pump pressure ports and are also provided free of charge.

No Leaks

Space saving system incorporates SAE flanges and hose connections on all components to provide a tight, leak-free design.

Design Flexibility

Allows you to combine any selection of state-of-the-art pressure, flow control, manual, electrical, and proportional valves with any combination of high performance vane pumps.

The "System Saver" concept utilizes standard catalogued hydraulic components. You simply size the pump and the rest of the components are automatically fixed in size. And, the pressure control, relief, flow control or check valve functions are the only functions that need to be specified.

System Saver - Single Vane Pump

VT6 * - *** - * - *** - ** - NU - D - GOQ - 1

Pump Model Code

VT6B, VT6C, VT6D, VT6E,
VT7QC, VT7B, VT7D/VT7DS,
VT7E/VT7ES

NU, UO, UB, NV, VO, VB

NU - Unloader
UO - Unloader with Vent valve (normally open)
UB - Unloader with Vent valve (normally closed)
NV - Relief valve
VO - Relief valve with Vent valve (normally open)
VB - Relief valve with Vent valve (normally closed)

Termination/Connection

1 - BSP threaded port
2 - NPTF threaded port
3 - Socket weld flange

Voltage/Frequency

W01 = 115 V - 60 Hz AC
W02 = 230 V - 60 Hz AC
W06 = 115 V - 50 Hz AC
W07 = 230 V - 50 Hz AC
GOR = 12 V DC
GOQ = 24 V DC
GOH = 48 V DC

Check valve

D - Unloading check valve
C - Check valve
N - None

Relief valve (NV)

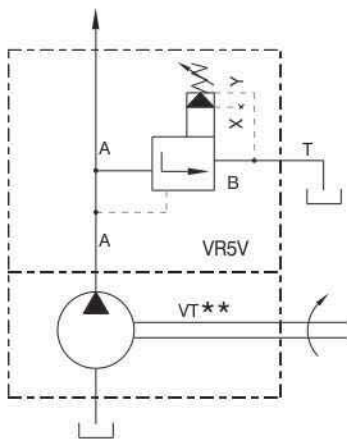

Unloader valve (NU)

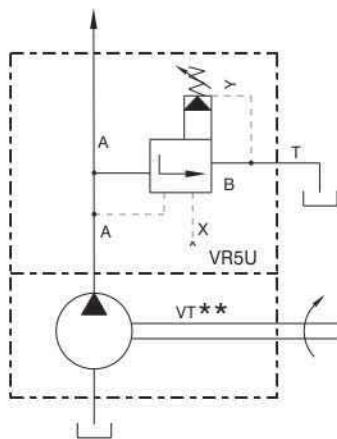

Unloader with Check valve (NUD)

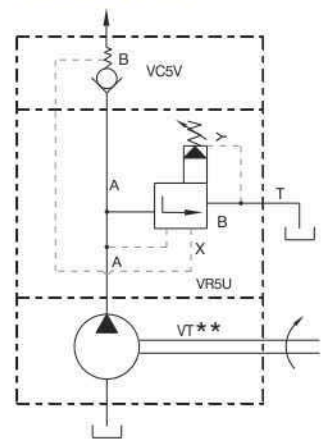

Unloader with Vent valve

normally open (UO)

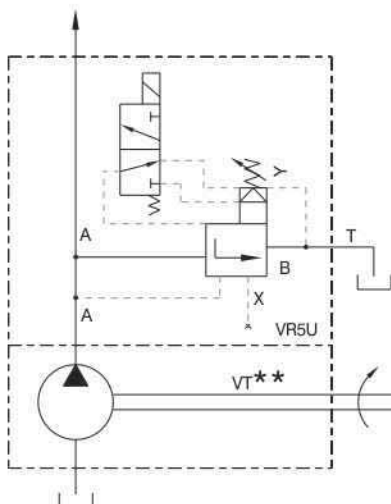

normally closed (UB)

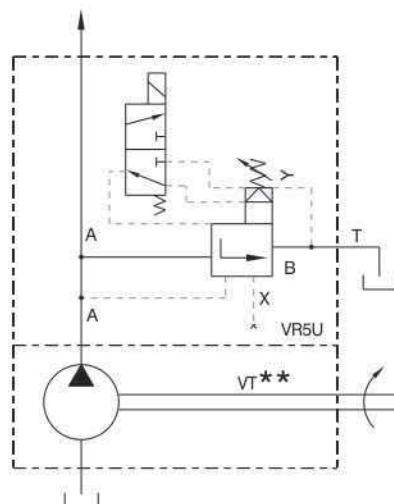

Relief valve + Check valve (NVC)

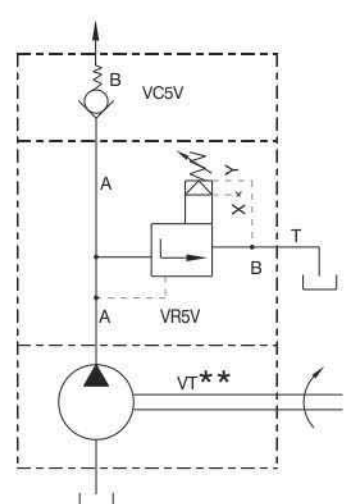

System Saver - Single Vane Pump

Relief valve with vent valve

normally open (VO)

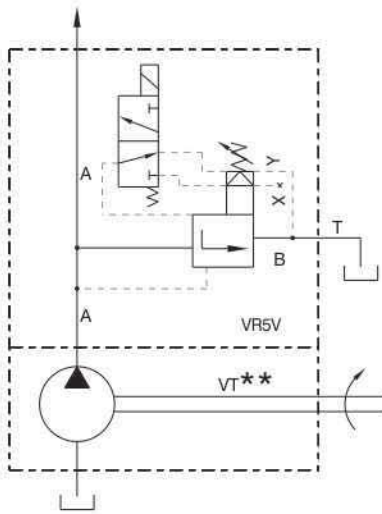

normally closed (VB)

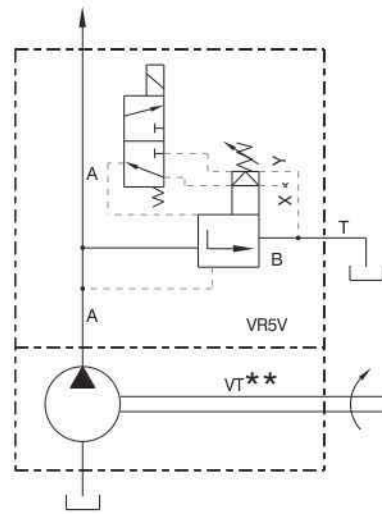

Unloader with Vent valve (normally open) + Unloading check valve (UOD)

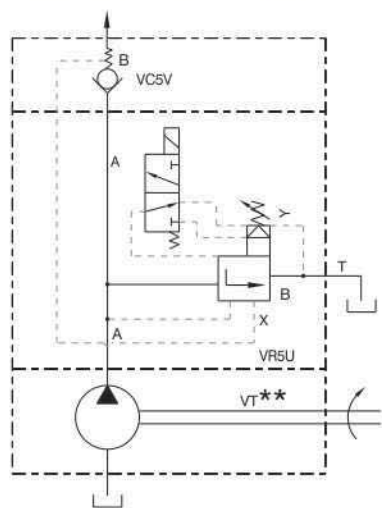

Unloader with Vent valve (normally closed) + Unloading check valve (UBD)

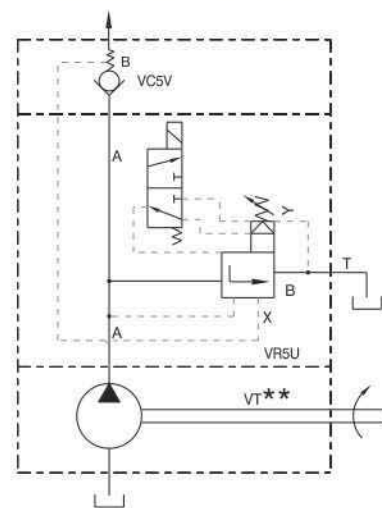

Relief valve with vent valve + Check valve

normally open (VOC)

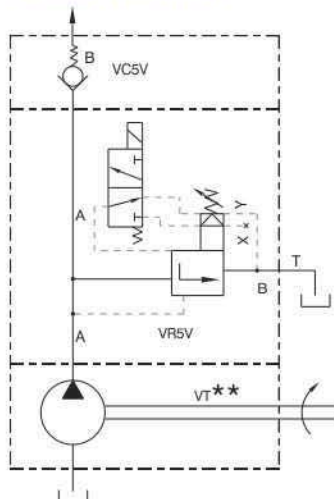

normally closed (VBC)

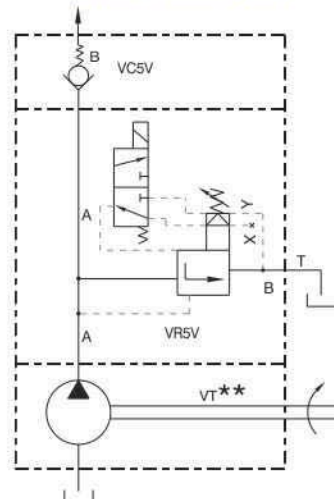

System Saver - Double Vane Pump

VT6 * - *** - * - *** - ** - NU - D - NV - C - GOQ - 1

Pump Model Code

VT6CC, VT7QCC, VT7BB-VT7BBS, VT6DC,
VT7DB-VT7DBS, VT6EC, VT7EBS-VT7EB,
VT6ED, VT7ED-VT7EDS, VT6DDS, VT7DD-VT7DDS,
VT6EE-VT6EES, VT7EE-VT7EES

NU, UO, UB, NV, VO, VB

NU - Unloader
UO - Unloader with Vent valve (normally open)
UB - Unloader with Vent valve (normally closed)
NV - Relief valve
VO - Relief valve with Vent valve (normally open)
VB - Relief valve with Vent valve (normally closed)

Check valve

D - Unloading check valve
C - Check valve
N - None

Termination/Connection

1 - BSP threaded port
2 - NPTF threaded port
3 - Socket weld flange

Voltage/Frequency

W01 = 115 V - 60 Hz AC
W02 = 230 V - 60 Hz AC
W06 = 115 V - 50 Hz AC
W07 = 230 V - 50 Hz AC
GOR = 12 V DC
GOQ = 24 V DC
GOH = 48 V DC

Relief/Unloader valve (NV/NU) - P1
Unloader/Relief valve (NU/NV) - P2

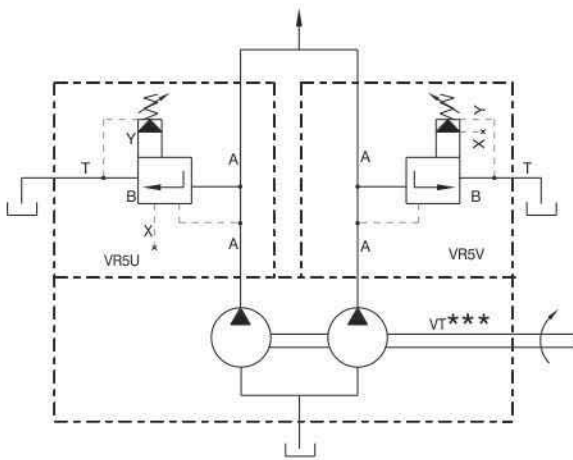

Relief/Unloader valve (NV/NU) - P1
Unloader/Relief with Check valve (NUD/NVC) - P2

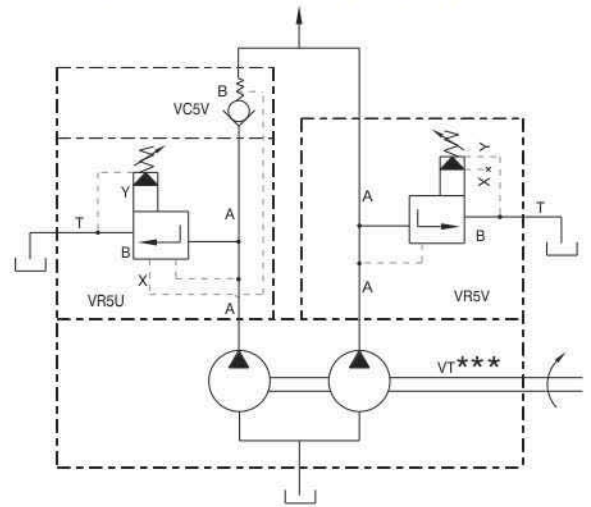

Unloader/Relief with Check valve (NUD/NVC) - P1
Unloader/Relief valve (NU/NV) - P2

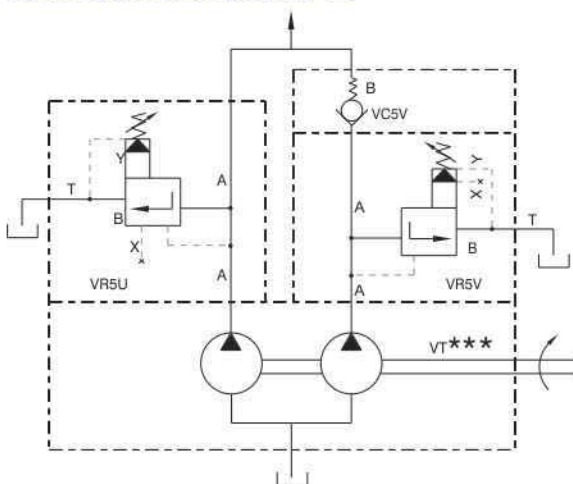

Unloader/Relief with Check valve (NUD/NVC) - P1
Unloader/Relief with Check valve (NUD/NVC) - P2

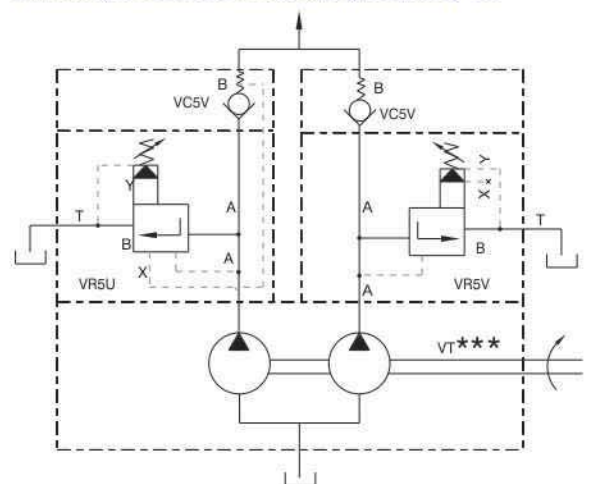

System Saver - Double Vane Pump

Relief/Unloader valve (NV/NU) - P1
Unloader/Relief with vent valve (UO-UB/VO-VB) - P2

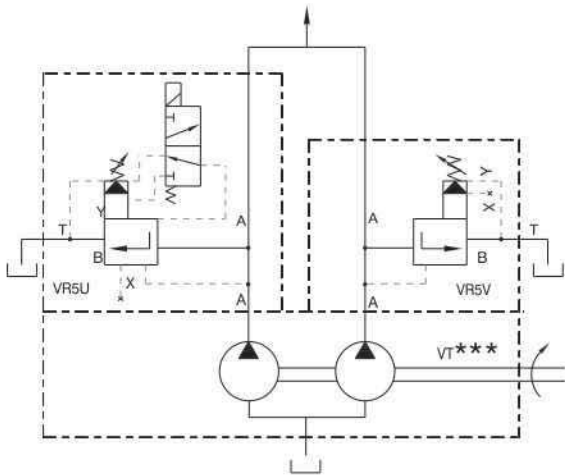

Unloader/Relief with vent valve (UO-UB/VO-VB) - P1
Relief/Unloader valve (NV/NU) - P2

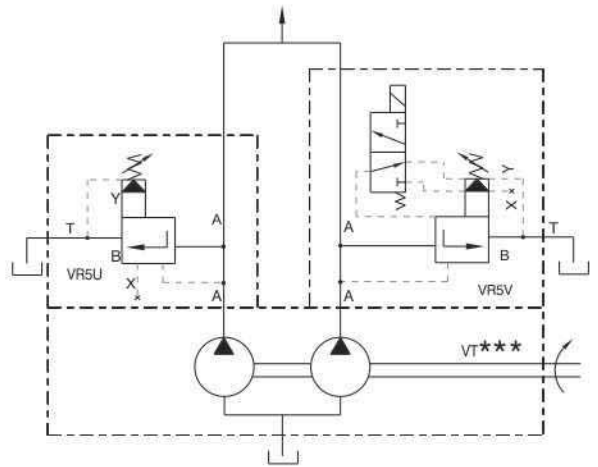

Relief/Unloader valve (NV/NU) - P1
Unloader/Relief with vent + Check valve (UOD-UBD/VOC-VBC) - P2

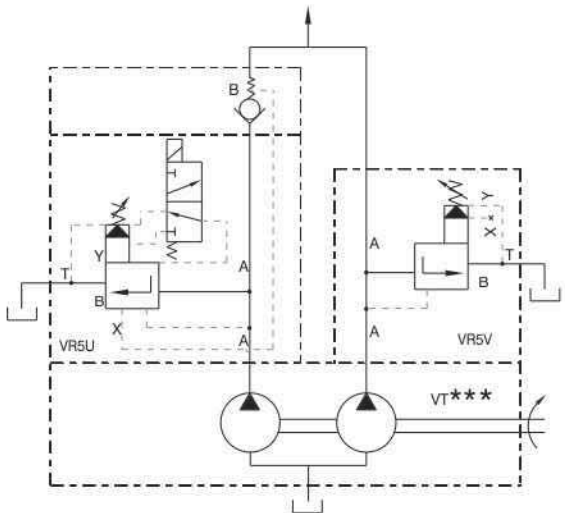

Unloader/Relief with vent + Check valve (UOD-UBD/VOC-VBC) - P1
Relief/Unloader valve (NV/NU) - P2

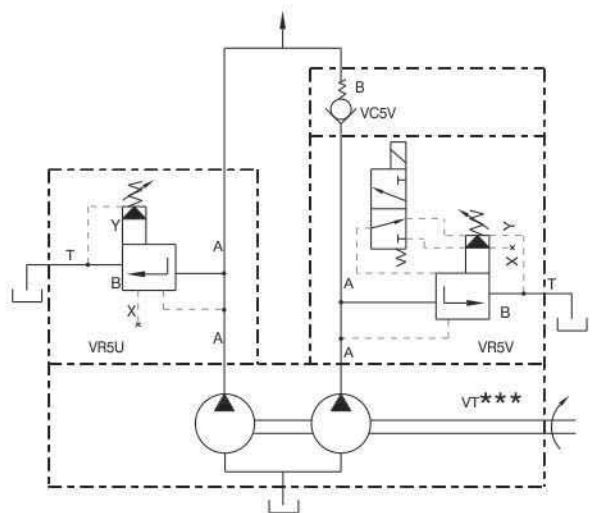

Unloader/Relief with vent valve (UO-UB/VO-VB) - P1
Unloader/Relief with vent valve (UO-UB/VO-VB) - P2

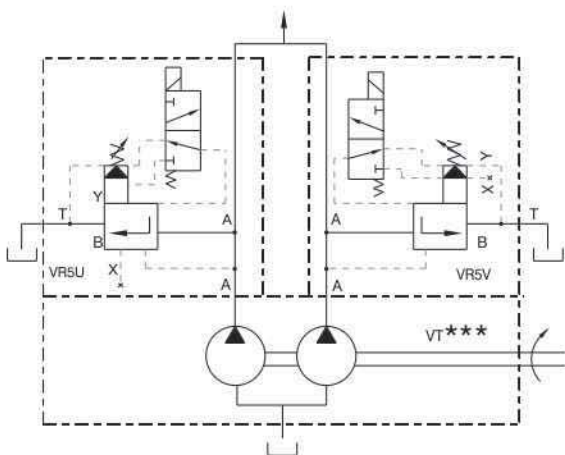

Unloader/Relief with vent + Check valve (UOD-UBD/VOC-VBC) - P1
Unloader/Relief with vent + Check valve (UOD-UBD/VOC-VBC) - P2

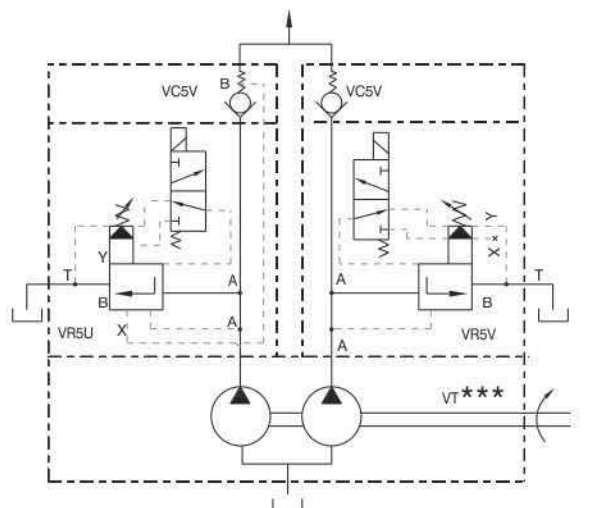

System Saver - Double Vane Pump

Relief/Unloader with vent valve (VO-VB/UO-UB) - P1
Unloader/Relief with Check valve (NUD/NVC) - P2

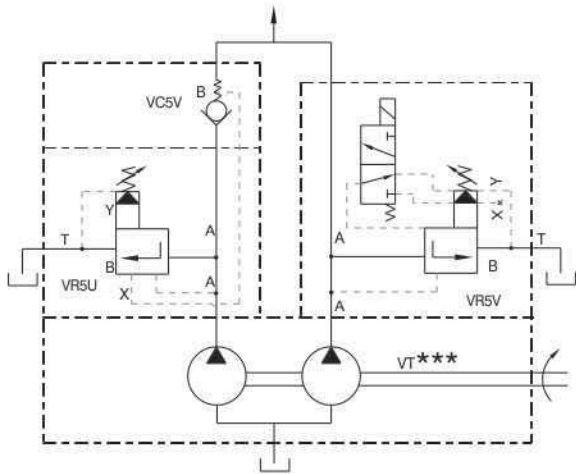

Relief/Unloader with Check valve (NVC/NUD) - P1
Relief/Unloader with vent valve (VO-VB/UO-UB) - P2

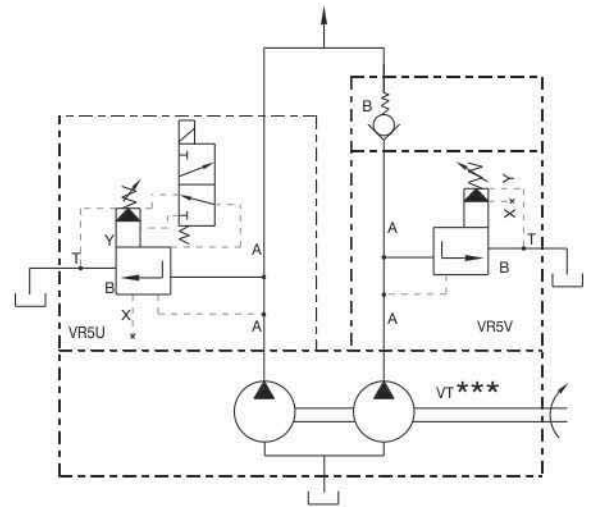

System Saver - Triple Vane Pump

VT6 *** - *** - *** - *** - * - *** - ** - ** - NU-D-NV-C-U0-D-GOQ-1

Pump Model Code

VT6CBB, VT6CCB, VT6DCB, VT6DCC, VT6DDCS, VT6EDC
VT7DDB, VT7DDBS, VT7EDB, VT7EDBS

NU, UO, UB, NV, VO, VB

NU - Unloader
UO - Unloader with Vent valve (normally open)
UB - Unloader with Vent valve (normally closed)
NV - Relief valve
VO - Relief valve with Vent valve (normally open)
VB - Relief valve with Vent valve (normally closed)

Check valve

D - Unloading check valve
C - Check valve
N - None

Termination

1 - BSP threaded port
2 - NPTF threaded port
3 - Socket weld flange

Voltage/Frequency

W01 = 115 V - 60 Hz AC
W02 = 230 V - 60 Hz AC
W06 = 115 V - 50 Hz AC
W07 = 230 V - 50 Hz AC
GOR = 12 V DC
GOQ = 24 V DC
GOH = 48 V DC

Relief/Unloader valve (NV/NU) - P1
Unloader/Relief valve (NU/NV) - P2
Unloader/Relief valve (NU/NV) - P3

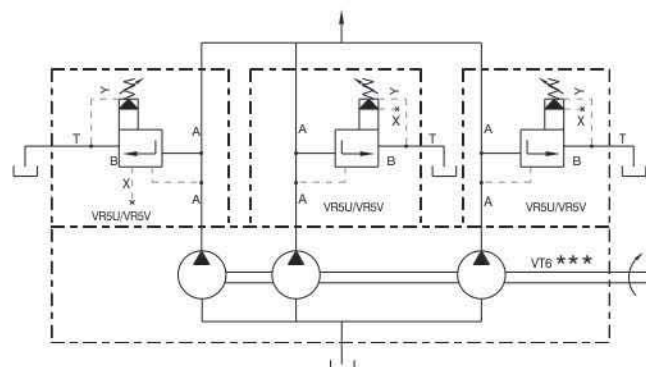

System Saver - Triple Vane Pump

Relief/Unloader valve (NV/NU) - P1
Unloader/Relief with check valve (NUD/NVC) - P2
Unloader/Relief valve (NU/NV) - P3

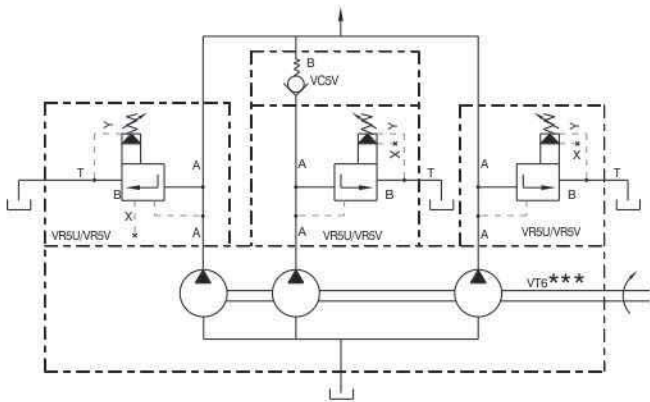

Relief/Unloader valve (NV/NU) - P1 & Relief/Unloader with vent valve (VO-VB/UO-UB) - P2
Unloader/Relief with Check valve (NUD/NVC) - P3

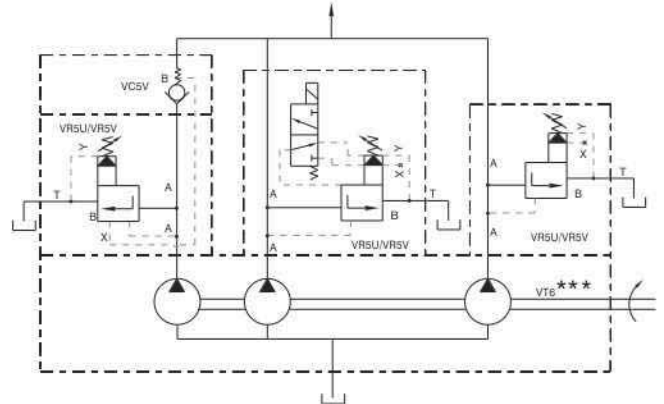

Relief/Unloader valve (NV/NU) - P1
Unloader/Relief with check valve (NUD/NVC) - P2
Unloader/Relief valve (NUD/NVC) - P3

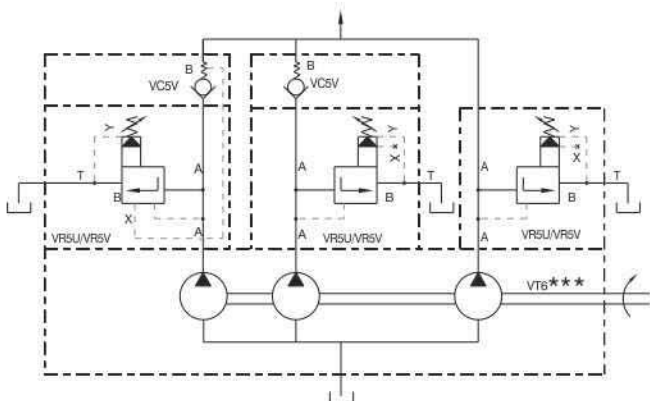

Relief/Unloader valve (NVC/NUD) - P1
Unloader/Relief with check valve (NUD/NVC) - P2
Unloader/Relief valve (NUD/NVC) - P3

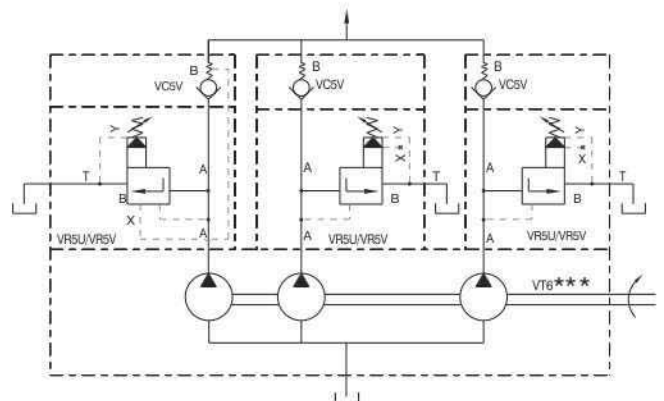

Relief/Unloader valve (NVC/NUD) - P1 & Relief/Unloader with vent valve (VO-VB/UO-UB) - P2
Unloader/Relief with Check valve (NUD/NVC) - P3

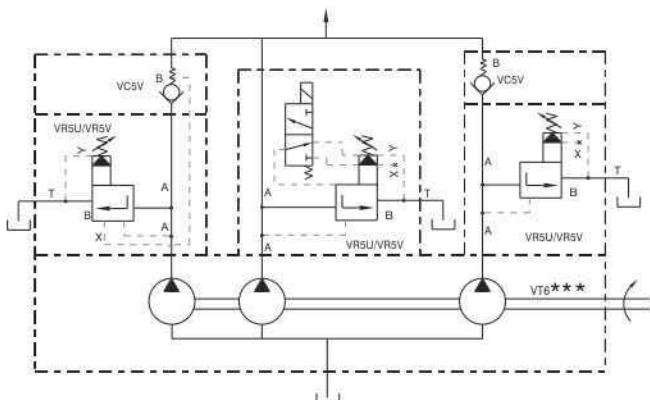

Relief/Unloader with vent valve (VO-VB/UO-UB) - P1 & Relief/Unloader with vent valve (VO-VB/UO-UB) - P2
Unloader/Relief with Check valve (NUD/NVC) - P3

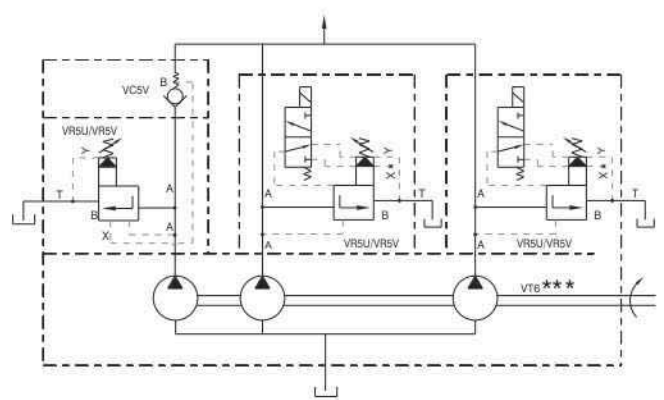

System Saver - Triple Vane Pump

Relief/Unloader with vent valve (VO-VB/UO-UB) - P1
 & Unloader/Relief with Check vane (NUD/NVC) - P2
 Relief/Unloader with vent valve (VO-VB/UO-UB) - P3

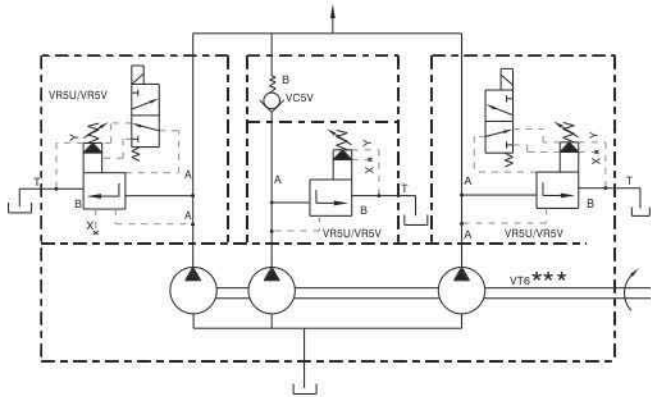

Relief/Unloader with vent valve (VO-VB/UO-UB) - P1
 & Relief/Unloader with vent valve (VO-VB/UO-UB) - P2
 Relief/Unloader with vent valve (VO-VB/UO-UB) - P3

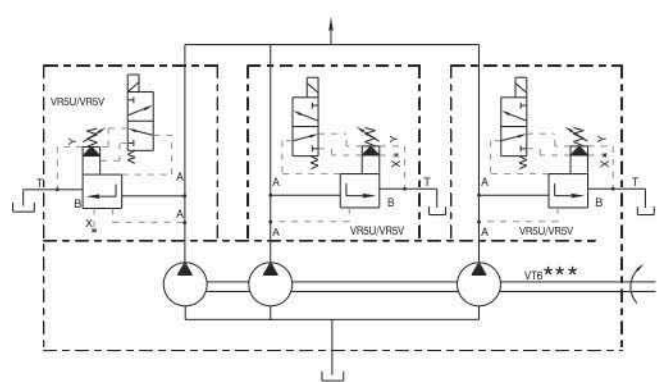

Unloader/Relief with vent +Check valve (UOD-UBD/VOC-VBC) - P1
 Unloader/Relief with vent +Check valve (UOD-UBD/VOC-VBC) - P2
 Unloader/Relief with Check vane (NUD/NVC) - P3

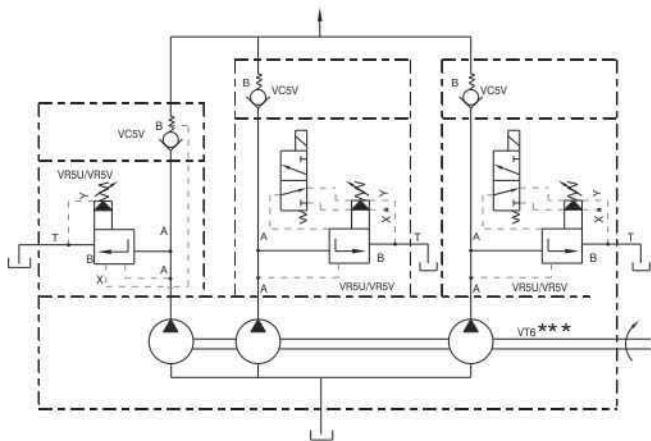

Unloader/Relief with vent +Check valve (UOD-UBD/VOC-VBC) - P1
 Unloader/Relief with vent +Check valve (UOD-UBD/VOC-VBC) - P2
 Unloader/Relief with vent +Check valve (UOD-UBD/VOC-VBC) - P3

